

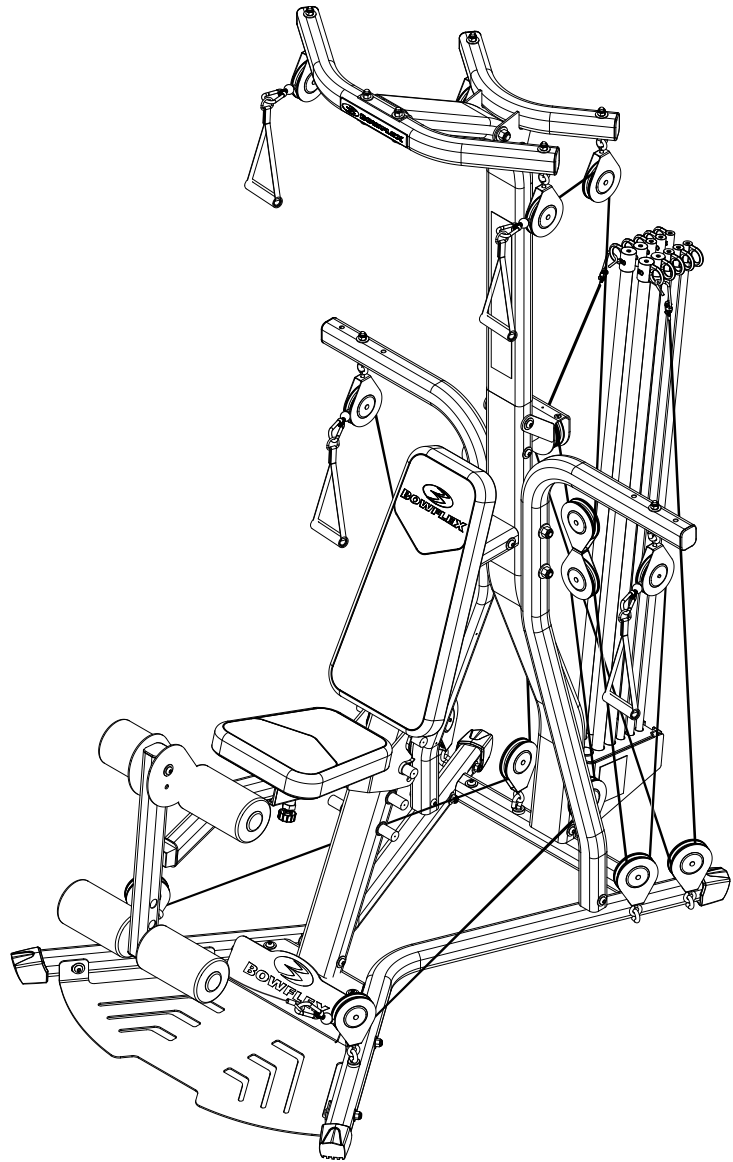

# PR3000 Home Gym



**Owner's Manual**



# Table of Contents

---

<b>Specifications</b> .....	<b>2</b>	Decline Bench Press .....	18
<b>Important Safety Instructions</b> .....	<b>3</b>	Incline Bench Press.....	19
Safety Warning Labels and Serial Number.....	4	Crossover High Rear Delt Rows.....	19
<b>Features and Use</b> .....	<b>6</b>	Seated Shoulder Press.....	20
How Often Should You Exercise.....	6	Shoulder Shrug .....	20
What to Wear .....	6	Lateral Shoulder Raise .....	21
Stretching .....	6	Shoulder Rotator Cuff - (Internal) .....	21
Power Rod® Resistance.....	8	Shoulder Rotator Cuff - (External).....	22
Adjusting and Understanding the Resistance .....	8	Standing Low Back Extension.....	22
Connecting the Power Rod® Unit to the Cables.....	8	Narrow Pulldowns with Hand Grips.....	23
Safety.....	8	Stiff Arm Pulldowns.....	23
When You Are Not Using Your Home Gym .....	8	Reverse Grip Pulldown with Hand Grips .....	24
Maintenance and Care of Your Gym .....	8	Triceps Pushdown.....	24
Accessories and Equipment.....	9	Triceps Extension.....	25
<b>Workouts</b> .....	<b>10</b>	Seated Biceps Curl.....	25
Define Your Goals .....	10	Triceps Kickback.....	26
Design Your Program .....	11	Seated (Resisted) Abdominal Crunch .....	26
Twenty Minute Better Body Workout.....	12	Trunk Rotation .....	27
Advanced General Conditioning .....	12	Leg Extension .....	27
Twenty Minute Upper/Lower Body.....	13	Squat.....	28
Body Building .....	14	Standing Hip Extension.....	28
Circuit Training - Anaerobic/Cardiovascular .....	15	Standing Hip Abduction.....	29
True Aerobic Circuit Training.....	16	Standing Hip Adduction.....	29
Strength Training.....	17	Standing Leg Kickback .....	30
<b>Exercises</b> .....	<b>18</b>	Standing Calf Raise .....	30
Bench Press .....	18	<b>Contacts</b> .....	<b>31</b>

## Specifications

---

### Physical Dimensions

Length (not in use) .....	63"(160cm)	Box Weight.....	174 lbs. (79kg)
Length (maximum in use).....	96"(244cm)	Box Dimensions.....	54"l x 28" w x 9" h
Width (in use and not in use) .....	78"(198cm)		(137cm x 71cm x 23cm)
Height.....	82"(208cm)	<b>Capacities</b>	
Weight .....	157 lbs. (71kg)	Maximum Weight Capacity .....	300 lbs. (158kg)

**Patent Information:** This product may be covered by US and Foreign Patents and Patents Pending. See Product for more information.

# Important Safety Instructions

---

 This icon means a potentially hazardous situation which, if not avoided, could result in death or serious injury.

## Before using this equipment, obey the following warnings

 Read and understand the complete Owner's Manual.  
Read and understand all Warnings on this machine.

- Keep children away from this machine. Monitor them closely when near the machine. Parts that move and appear dangerous to adults can appear safe to children.
- Consult a physician before you start an exercise program. Stop exercising if you feel pain or tightness in your chest, become short of breath, or feel faint. Contact your doctor before you use the machine again.
- Examine this machine for loose parts or signs of wear. Monitor all cables and belts and their connections. Contact Nautilus Customer Service for repair information.
- Maximum user weight limit: 300 lbs. (136kg). Do not use if you are over this weight.
- This machine is for home use only.
- Do not wear loose clothing or jewelry. This machine contains moving parts.
- Set up and operate this machine on a solid, level, horizontal surface.
- Keep at least 36" (0.9m) on each side of the machine clear. This is the recommended safe distance for access and passage around and emergency dismounts from the machine. Keep third parties out of this space when machine is in use.
- Do not over exert yourself during exercise. Operate the machine in the manner described in this manual.
- Do not use Dumbbells or other weight equipment to incrementally increase the weight resistance. Use only the weight resistance that came with your gym.
- Correctly engage the Selector Hook to the Rod End.
- Correctly adjust and safely engage all Positional Adjustment Devices. Make sure that the Adjustment Devices do not hit the user.

# Important Safety Instructions

## Safety Warning Labels and Serial Number

Locate and read all safety warnings before operation. Replace any warning label if it is damaged, illegible, or missing. For replacement labels, call a Nautilus® Representative. Refer to the Contacts page at the back of this manual.

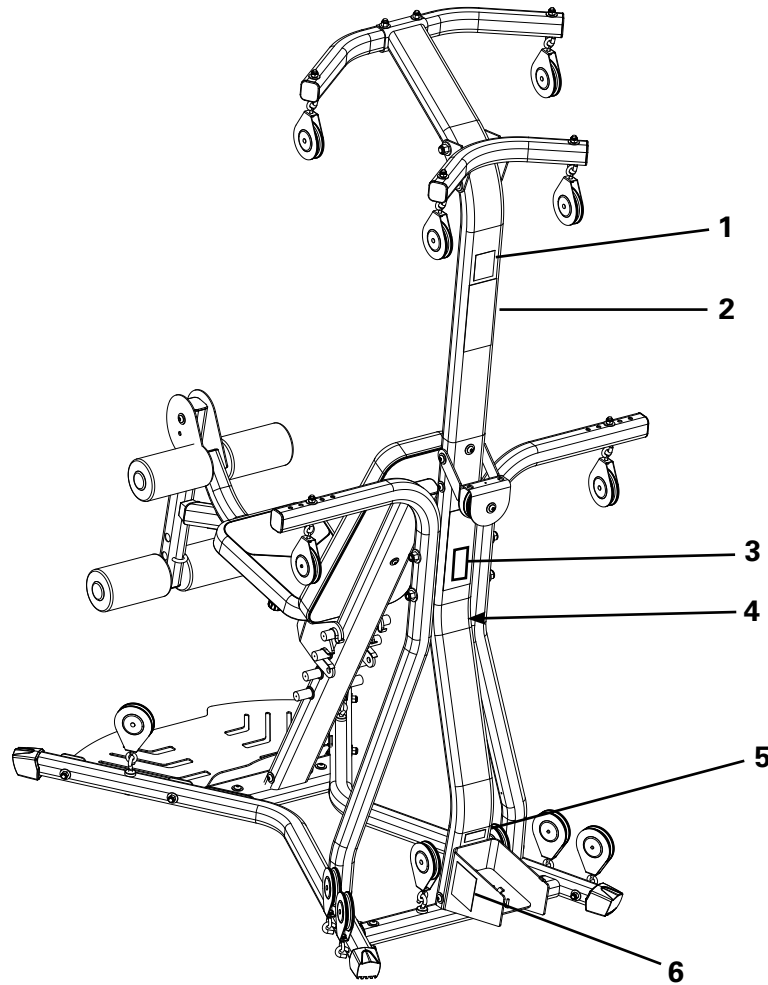

**NOTE:** Power Rod® Unit removed for clarity.

Type	Description
1 WARNING	<ul style="list-style-type: none"><li>* Misuse or abuse of this equipment may lead to serious injury.</li><li>* Keep children away and supervise teenagers using equipment.</li><li>* Obtain, read and understand the owner's manual provided with this fitness equipment prior to use.</li><li>* Replace this or any other warning label if damaged, illegible or missing.</li></ul>

# Important Safety Instructions

	Type	Description
2	CAUTION	Before each use check all snap hooks, cables and pulleys for wear and proper function. Tighten all fasteners as necessary.
	MISE EN GARDE	Avant chaque utilisation, vérifiez le fonctionnement de tous les mousquetons, câbles et poulies. Serrez bien toutes les fixations au besoin.
	VORSICHT	Überprüfen Sie alle Karabinerhaken, Kabel und Rollen vor jeder Benutzung auf Abnutzungserscheinungen und Fehlfunktionen. Ziehen Sie alle Befestigungselemente ordnungsgemäß an.
	PRECAUCIÓN	Antes de cada uso, revise todos los cierres a presión, cables y poleas para asegurarse de que no estén desgastados y que funcionan correctamente. Apriete todos los sujetadores según sea necesario.
3	NOTICE	Engineered in the USA, Made in China
4	WARNING	The Maximum User Weight for this machine is 300 pounds (136 KG). This machine is for Home use only.
	WARNUNG	Das Maximale Belastungsgewicht für diese Maschine beträgt 136 kg. Dieses Gerät ist nur für die Nutzung im Heimbereich freigegeben.
	AVERTISSEMENT	Le poids maximum de l'utilisateur pour cette machine est de 136 kg (300 livres). Cet équipement est destiné à un usage privé uniquement.
	ADVERTENCIA	El peso máximo para el usuario de esta Máquina es de 136 kg (300 libras). Este equipamiento sólo se puede utilizar en el hogar.
5	Serial Number	Record serial number on Contacts page at end of this manual.
6	CAUTION	At all times, stay out of the paths of moving rods.
	MISE EN GARDE	Restez toujours à l'écart des tiges mobiles.
	VORSICHT	Halten Sie stets Abstand zu beweglichen Stangen.
	PRECAUCIÓN	En todo momento, manténgase alejado del trayecto de las barras móviles.

# Features and Use

---

-  **Consult your physician before starting any exercise program.** If you have not exercised recently, are pregnant, have a heart condition, or any physical limitation, consult with your physician before you use your machine. If you experience tightness in your chest, an irregular heartbeat, shortness of breath, feel faint, lightheaded or dizzy, or have any pain, STOP and consult your physician immediately.

## How Often Should You Exercise

- 3 times a week for 20 minutes each day.
- Schedule workouts in advance. Try to work out even when you don't want to.

## What to Wear

Wear rubber-soled athletic shoes. You will need the appropriate clothes for exercise that allow you to move freely.

## Stretching

Stretch before starting your exercise session. Warm muscles respond better to exercises.

- Achilles Tendon and Calf - With both hands against a wall, place one foot behind you. Lean in toward the wall while keeping the rear leg straight and your heel on the ground. Repeat for the other leg.
- Quadriceps - Put your left hand on a wall or table for balance. Reach your right hand behind your back and grasp your right ankle, pull it gently toward your buttocks until you feel tension along the front of your thigh. Repeat on the other side.
- Hamstring - Stand on one leg and prop the other leg parallel to the ground on a stable cabinet or table top. Slide both hands toward the propped-up ankle as far as is comfortable. Repeat on other side.

# Features and Use

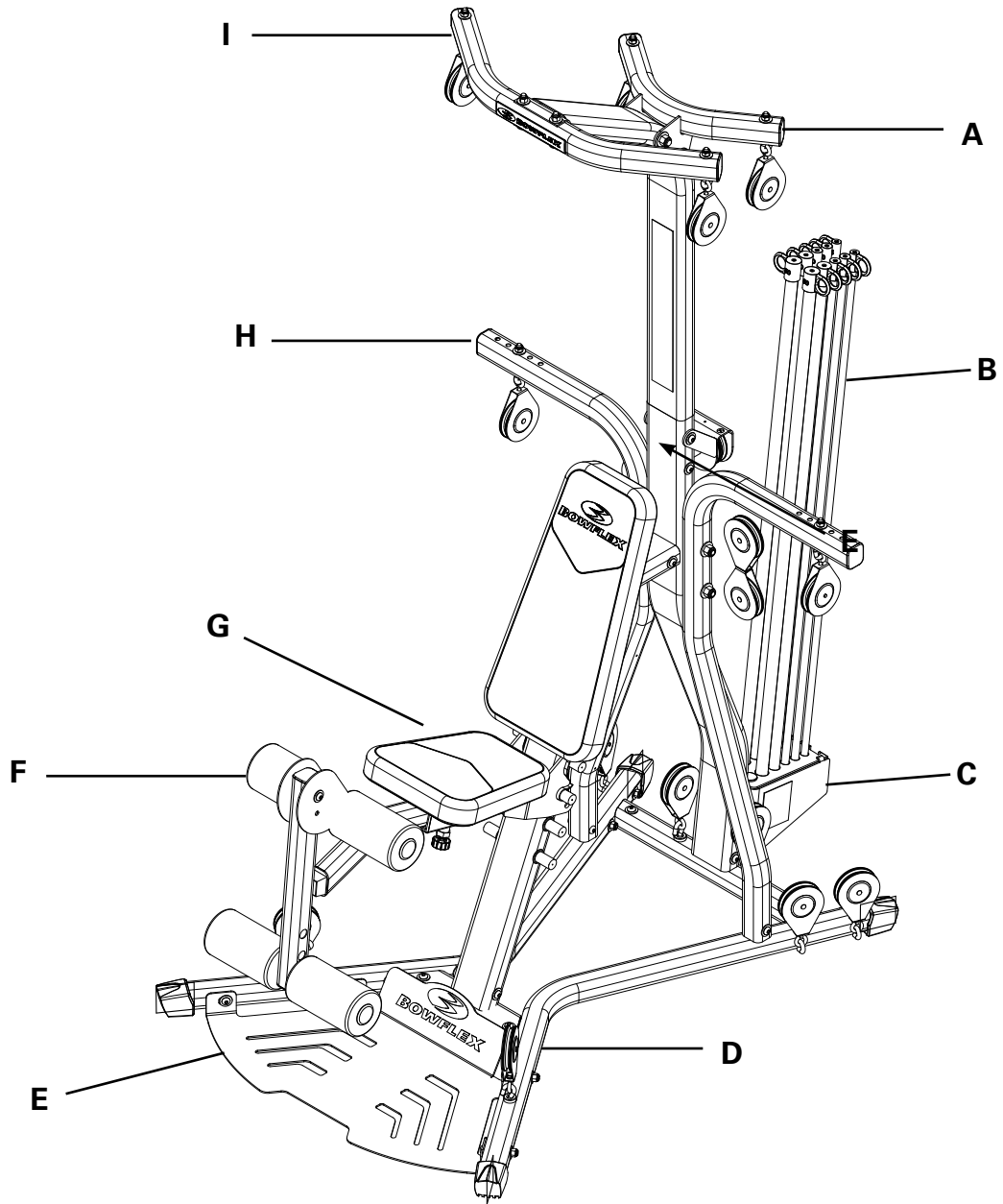

A	Rear Lat Cross Bar	F	Leg Attachment
B	Power Rod® Unit	G	Seat Assembly
C	Rod Box	H	Chest Bar
D	Squat Pulley Frame	I	Lat Cross Bar with Pulleys
E	Standing Platform		

# Features and Use

## Power Rod® Resistance

Power Rod® units are made from a special composite material. The rods are sheathed with a protective black rubber coating. Each rod is marked with its weight rating on the "Rod Cap".

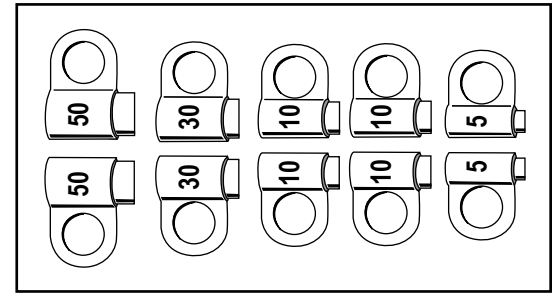

## Adjusting and Understanding the Resistance

The Bowflex® PR3000 home gym comes with 210 lbs. (95kg) of resistance [one pair of 5 lb. (2.25kg) rods, two pair of 10 lb. (4.5kg) rods, one pair of 30 lb. (13.5kg) rods, and one pair of 50 lb. (22.5kg) rods].

## Connecting The Power Rod® Unit to the Cables

You may use one rod or several rods in combination, to create your desired resistance level.

To hook multiple rods up to one cable, bend the closest rod toward the cable and place the cable hook through that rod cap. You can then hook up the next closest rod through the same cable hook.

Hooking up the closest rod first prevents rods from crossing over the top of one another.

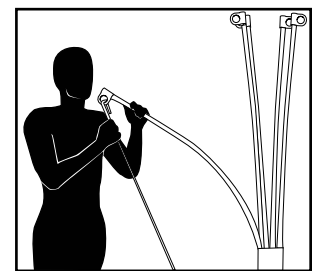
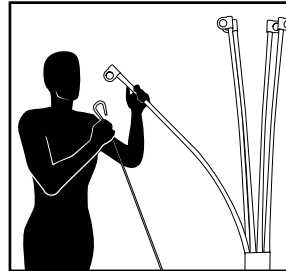

## Safety



When connecting the Power Rod® unit to the cable hooks and disconnecting them, do not stand so that you are looking directly over the top of the rods. Stand off to the side, so that if a rod is accidentally released, you will not be struck by it.

## Maintenance and Care of Your Bowflex® Home Gym

Inspect your machine for any worn or loose components prior to use. Tighten or replace any worn or loose components prior to use. Pay close attention to cables, or belts and their connections.

Clean the bench with a non-abrasive household cleaner after each use. This will keep it looking new. Do not use automotive cleaner, which can make the bench too "slick".

Review all warning notices. The safety and integrity designed into a machine can only be maintained when the equipment is regularly examined for damage and repaired. It is the sole responsibility of the owner to ensure that regular maintenance is performed. Worn or damaged components shall be replaced immediately or the equipment removed from service until the repair is made. Only manufacturer supplied components shall be used to maintain/repair the equipment.

If you have any questions regarding your Bowflex® home gym, call the Nautilus® Customer Service Department at 1-800-NAUTILUS (1-800-628-8458).

## When You Are Not Using Your Home Gym

Disconnect the cables from the Power Rod® unit when you are not using your home gym. Use the rod binding strap included with your machine to bind all the rods together at the top. You can also place your cables and grips through the strap to keep them out of the way. Leaving the rods and cables under tension could cause injury if a rod were inadvertently released.

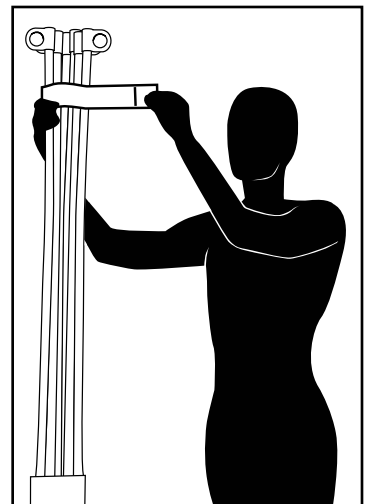
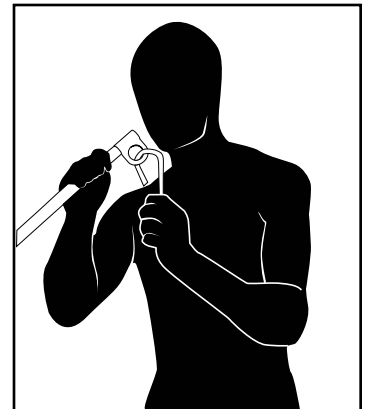



# Features and Use

## Accessories and Equipment

### Handgrips

After fitting the handgrips firmly to your hand, ankle, or wrist, attach the pulley cable clips to the D-rings on the handgrips to attach them to the cables.

**Standard Grip:** Grasp the grip and cuff together to form a grip without inserting your hand through the cuff portion. Most of the exercises you perform utilize this grip. The Standard Grip also is used for Hammer Grip exercises, when you need to hold the Handgrip vertically for greater wrist support.

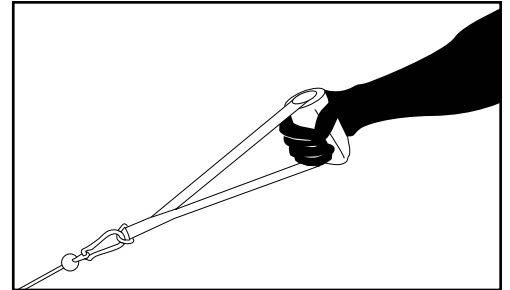

**Hand Cuff Grip:** Slip your hand through the cuff portion of the grip so that the foam pad rests on the back of your hand. Then grasp the remainder of the grip that is sitting in your palm. This method of gripping is great for exercises like front shoulder raises or any exercise where your palm is facing down.

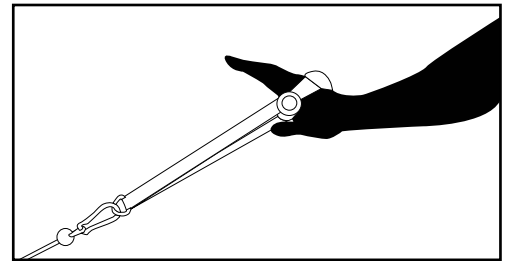

**Ankle Cuff Grip:** The cuff opening can be made larger to accommodate the ankle. Place your hand in the cuff and slide it away from the grip. Insert your foot or ankle and tighten by sliding the grip back toward the cuff.

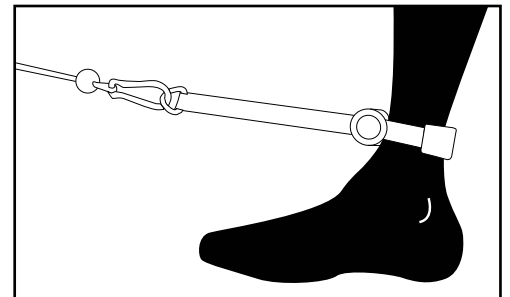

**Foot Grip:** Slip your foot through the cuff of the handle and slide the foam grip against the top of your foot.

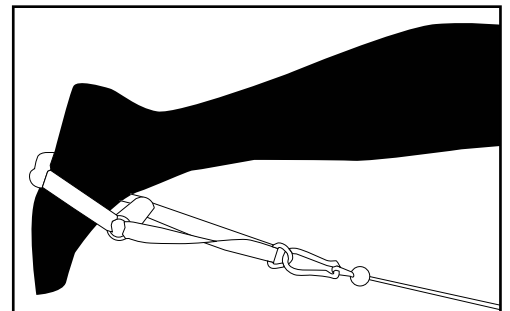

**Shoulder Grip:** Spread open the cuff and slide the grip up your arm, tightening the grip around your shoulder by pulling the handle toward the cuff.

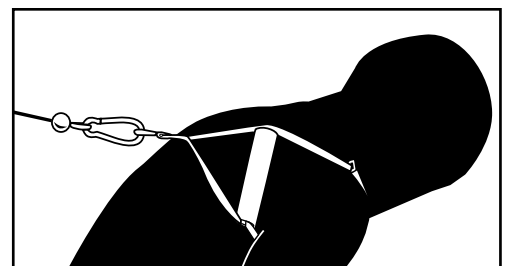

### Additional Accessories

For additional accessories for your home gym, contact Nautilus at 1-800-NAUTILUS (1-800-628-8458) or [www.bowflex.com](http://www.bowflex.com).

# Workouts

---

## Define Your Goals

It is important to define your goals before you begin your workout routine. The following fitness guidelines will help you define your goals and choose your fitness program.

**Muscle Strength** is the maximum force that you can exert against resistance at one time. Your muscle strength comes into play when you pick up a heavy bag of groceries or lift a small child. It is developed when a localized muscle is worked both positively (concentric) and negatively (eccentric) at a resistance—great enough so you can perform only five to eight repetitions of the exercise before the muscle fails. Each set of repetitions is followed by a rest interval that typically runs three times longer than the set. Later, between exercise sessions, the muscle overcompensates for the stress and usually increases in both strength and size.

**Muscle Endurance** is the ability to perform repeated contractions. It comes into play when you cross-country ski or work on your feet all day. Endurance training addresses the slow twitch, endurance muscle fibers, which depend on oxygen for energy. To develop muscle endurance, use low resistance and high repetitions about 15-20 repetitions in each set, three sets to each exercise, working the muscle only to fatigue.

**Muscle Power** is the combination of strength and speed of the muscular contraction. This is often misinterpreted as; a) being directly associated with certain skill or sport and/or; b) meaning that you must move fast. Load is actually a more important factor than speed when attempting to improve power. When training to achieve muscular power, pick a resistance that fatigues you in the 3-5 repetition range. When performing these reps, it is more important to think of contracting the muscles faster rather than attempting to move faster. Performing sport simulation exercises usually results in a deterioration of the motor pattern or skill. The biomechanically sound method of improving power in your sport is to train for power using the correct joint movements, as described in this manual. Then practice the skill associated with your sport, learning to apply this newly achieved power.

**Body Composition** is the ratio of fat weight (fat) to lean weight (muscles, bones and tissue). As you age, the ratio shifts. The fat weight increases and the lean weight decreases. Training for muscle strength will generally increase muscle size and aerobic conditioning will help burn extra calories. Performing these two forms of

exercise, either at different times or together, will create the greatest changes in body fat weight. Balanced Strength and alignment are the result of equal strength developed in all parts of the body. It comes into play in your standing and sitting posture, and in your ability to perform just about any activity safely and effectively. An over-development of the back will round the shoulders, weak or stretched abdominals can cause lower back pain. You want a balance of muscle strength in front and back. In addition, you need a balance of strength between your middle, lower, and upper body.

**Flexibility** is the ability of a muscle or group of muscles to move the joint through a full range of motion. Flexibility comes into play when you execute an overhand serve or stretch for the top shelf in the kitchen. It is a cooperative movement of opposite muscle groups. When a muscle contracts, its opposite muscle group must relax for the action to occur. Increased flexibility means an increased range of motion, made possible by this simultaneous contracting and relaxing. Good flexibility is important in protecting the body from injury and can be achieved through the balanced strength training programs that are included in this manual.

**Cardiovascular Endurance** is the ability of the heart and lungs to supply oxygen and nutrients to exercising muscles over an extended period of time. It comes into play when you jog a mile or ride a bike. It is a critical component of overall fitness and health.

# Workouts

---

## Design Your Own Program

You may want to design your own personal program specifically geared to your goals and lifestyle. Designing a program is easy by following the guidelines below.

### Understand fitness and its components

Improperly designed programs can be dangerous. Take some time to review this manual as well as other fitness guides.

### Know your current fitness level

Before you start any fitness program you should consult a physician who will help you determine your current abilities.

### Identify your goals

Goals are critical to choosing and designing an exercise program that fits and enhances your lifestyle, but so is strategy. It's important not to rush the process and try to accomplish too much too soon. That will lead to setbacks and discouragement. Instead, set a series of smaller achievable goals.

### Select complementary exercises

Be sure to pair exercises that address compound joint movements and single joint movements. In addition, select exercises that address complementary muscle groups.

### Put first things first

During each session, first work muscle groups that need the most training.

### Remember your cardiovascular component

Any fitness program must contain a cardiovascular fitness component to be complete. So complement your resistance training with aerobic exercise such as walking, running, or bicycling.

### Training variables

When designing your own program there are several variables that, when mixed properly, will equal the right fitness formula for you. In order to find out the best formula, you must experiment with several combinations of variables.

### The variables are as follows

- **Training Frequency:** The number of times you train per week. We recommend daily activity but not daily training of the same muscle group.
- **Training Intensity:** The amount of resistance used during your repetition.
- **Training Volume:** The number of repetitions and sets performed.

- **Rest Intervals:** The time you rest between sets and the time you rest between workouts.

### Once you've established a base of fitness, follow these basic principles

- **Isolate Muscle Groups:** Focus work on specific muscle groups.
- **Progressive Loading:** The gradual systematic increase of repetitions, resistance and exercise period.

### Working Out

A good pre-workout mental routine is to sit and relax, so that you can focus on what you are about to do and think about achieving your end goal.

### Warming Up

We recommend that you warm up by doing light stretching and performing light exercises on the Bowflex® home gym.

### Cooling Down

An essential part of the exercise routine is the cool down. Gradually reduce the level of exercise intensity so that blood does not accumulate in one muscle group, but continues to circulate at a decreasing rate. Remember to gradually move yourself into a relaxed state.

### Breathing

Breathing in or out during the actual performance is not dependent upon the direction of air flow relative to exertion. It is, in fact, a mechanical process that changes the position of your spine as your rib cage moves. Here are some tips for breathing:

1. Be cautious when you are concentrating or exerting effort. This is when you will probably hold your breath. Do not hold your breath. Do not exaggerate breathing. Depth of inhalation and exhalation should be natural for the situation.
2. Allow breathing to occur naturally, do not force it.

# Workouts

## Workouts

### 20 Minute Better Body Workout

**Frequency:** 3 days per week (M-W-F)

**Time:** 20 minutes

Start by performing one set of each exercise. Warm up with a light resistance that you can perform easily for 5–10 reps without fatigue. Focus on practicing and learning your technique before increasing the resistance. Then move to a more challenging resistance that you can perform no less than 10 reps and no more than 15 reps. As you become stronger, you can advance to two sets for each exercise. Complete all sets of each exercise before moving on to the next one. Rest 30 to 45 seconds between sets. Move slowly on each rep. Use a pace that would allow you to stop the movement instantly at any point in the rep. Count three seconds up and three seconds down and work to fatigue during each set.

Body Part	Exercise	Sets	Reps
Chest	Bench Press	1-2	10-15
Back	Narrow Pulldown with Hand Grips	1-2	10-15
Shoulders	Crossover High Rear Delt Rows	1-2	10-15
Arms	Seated Biceps Curl	1-2	10-15
	Triceps Pushdown	1-2	10-15
Legs	Leg Extension	1-2	10-15
	Standing Hip Extension	1-2	10-15
Trunk	Standing Low Back Extension	1-2	10-15
	Seated Abdominal Crunch	1-2	10-15

### Advanced General Conditioning

**Frequency:** 3 days per week (M-W-F)

**Time:** 20 minutes

When you are proficient in performing the exercise techniques of the above workout and are no longer realizing results, or have become just plain bored, it is time to change your program. You can increase your training with this "split system" routine that works opposing muscle groups on different days. To do this, you will increase your resistance when you can perform 12 reps perfectly, and you will increase your volume by performing more sets and more exercises. Move slowly on each rep. Use a pace that would allow you to stop the movement instantly at any point in the rep. Count three seconds up and three seconds down and work to fatigue during each set.

#### Days 1 & 3

Body Part	Exercise	Sets	Reps
Chest	Bench Press	1-3	10-12
Shoulders	Seated Shoulder Press	1-3	10-12
Arms	Triceps Pushdown	1-3	10-12
	Seated Biceps Curl	1-3	10-12
Legs	Leg Extension	1-3	10-12
	Squat	1-3	10-12

# Workouts

Days 2 & 4	Body Part	Exercise	Sets	Reps
	Back	Reverse Grip Pulldown with Hand Grips	1-3	10-12
		Narrow Pulldown with Hand Grips	1-3	10-12
	Shoulders	Crossover High Rear Delt Rows	1-3	10-12
	Arms	Seated Biceps Curl	1-3	10-12
		Triceps Pushdown	1-3	10-12
	Trunk	Standing Low Back Extension	1-3	10-12
		Seated Abdominal Crunch	1-3	10-12

## 20 Minute Upper/Lower Body

**Frequency:** 4 days per week (M-T-Th-F)

**Time:** 20 minutes

This program provides a quick and effective workout that combines muscle conditioning with some cardiovascular benefits. Perform this routine when you are limited in time or just want a variation to your normal routine. Perform this program training 2 days, resting 1 to 2. Perform all exercises to near failure, stopping at the point that your technique starts to deteriorate. Rest only 20-30 seconds between sets. As you get stronger, increase the number of sets you perform. Move slowly on each rep. Use a pace that would allow you to stop the movement instantly at any point in the rep. Count three seconds up and three seconds down.

Days 1 & 3	Body Part	Exercise	Sets	Reps
	Chest	Bench Press	1-3	12-15
	Back	Stiff Arm Pulldowns	1-3	12-15
	Shoulders	Crossover High Rear Delt Rows	1-3	12-15
	Arms	Seated Biceps Curl	1-3	12-15
		Triceps Extension	1-3	12-15

Days 2 & 4	Body Part	Exercise	Sets	Reps
	Legs	Leg Extension	1-3	12-15
		Squat	1-3	12-15
		Standing Hip Extension	1-3	12-15
		Standing Hip Abduction	1-3	12-15
	Trunk	Standing Low Back Extension	1-3	10-12
		Seated Abdominal Crunch	1-3	10-12

# Workouts

## Body Building

**Frequency:** 3 days on, 1 day off (Day 6)

**Time:** 45-60 minutes

Body building requires focused concentration and dedication to training, as well as proper eating habits. Train each muscle group to fatigue before moving on to the next exercise. Do not neglect any muscle group. If needed, include an aerobic activity to increase your caloric expenditure and help to reduce your body fat levels to achieve a defined muscular look. Rest 30-60 seconds between each set and exercise. Focus on proper form. Tighten the muscle before you move, squeeze the muscle as you move, cramp the muscle at the point of full contraction, and resist the movement as you lower the weight. Move slowly on each rep. Use a pace that would allow you to stop the movement instantly at any point in the rep. Count three seconds up and three seconds down and work to fatigue during each set.

### Days 1 & 3

Body Part	Exercise	Sets	Reps
Chest	Bench Press	2-4	8-12
	Incline Chest Press	2-4	8-12
Shoulders	Seated Shoulder Press	2-4	8-12
	Crossover High Rear Delt Rows	2-4	8-12
	Lateral Shoulder Raise	2-4	8-12
	Shoulder Shrug	2-4	8-12

### Days 2 & 4

Body Part	Exercise	Sets	Reps
Back	Stiff Arm Pulldowns	2-4	8-12
	Narrow Pulldown with Hand Grips	2-4	8-12
Arms	Seated Biceps Curl	2-4	8-12
	Triceps Kickback	2-4	8-12
	Triceps Pushdown	2-4	8-12
	Triceps Extension	2-4	8-12

### Days 5 & 7

Body Part	Exercise	Sets	Reps
Legs	Squat	2-4	8-12
	Leg Extension	2-4	8-12
	Standing Hip Extension	2-4	8-12
	Standing Leg Kickback	2-4	8-12
Trunk	Standing Low Back Extension	2-4	8-12
	Seated Abdominal Crunch	2-4	8-12
	Trunk Rotation	2-4	8-12

# Workouts

## Circuit Training - Anaerobic/Cardiovascular

**Frequency:** 3 days on, 1 day off (Day 6)

**Time:** 20-45 minutes

Circuit training is a great way to achieve the benefits of strength training and cardiovascular training in one quick, challenging routine. The idea is to move quickly from exercise to exercise, taking only as much rest between sets as it takes to set up the next exercise (less than 20 seconds). One circuit equals one set of each exercise. Initially, start with completing one round of Circuit 1. Then add an additional round of the same circuit. Once you reach three rounds of Circuit 1, add one round of Circuit 2. Add additional rounds of Circuit 2 as your fitness level increases. Repeat the process with Circuit 3. Do not let your heart rate exceed 220, minus your resting heart rate. Perform each rep of each exercise slowly. Count three seconds up and three seconds down.

<b>Days 1 &amp; 3</b>	<b>Body Part</b>	<b>Exercise</b>	<b>Reps</b>
	Chest	Bench Press	8-12
	Legs	Squat	8-12
	Back	Stiff Arm Pulldowns	8-12
	Legs	Standing Extension	8-12
	Trunk	Seated Abdominal Crunch	8-12

<b>Days 2 &amp; 4</b>	<b>Body Part</b>	<b>Exercise</b>	<b>Reps</b>
	Shoulders	Seated Shoulder Press	8-12
	Legs	Leg Extension	8-12
	Back	Narrow Pulldown with Hand Grips	8-12
	Trunk	Standing Low Back Extension	8-12
	Arms	Seated Biceps Curl	8-12

<b>Days 5 &amp; 7</b>	<b>Body Part</b>	<b>Exercise</b>	<b>Reps</b>
	Shoulders	Shoulder Shrug	8-12
	Arms	Triceps Pushdown	8-12
	Legs	Standing Hip Adduction	8-12
	Trunk	Trunk Rotation	8-12

# Workouts

## True Aerobic Circuit Training

**Frequency:** 2-3 times per week

**Time:** 20-60 minutes

Circuit training is a great way to achieve the benefits of strength training and cardiovascular training in one quick, challenging routine. By returning to an aerobic exercise between each set you are increasing your aerobic capacity, endurance and burning fat as energy. The idea is to move quickly from exercise to exercise, taking only as much rest between sets as it takes to set up the next exercise (less than 20 seconds). One circuit equals one set of each exercise. Initially, start with completing one round of Circuit 1. Then add an additional round of the same circuit. Once you reach three rounds of Circuit 1, add one round of Circuit 2. Add additional rounds of Circuit 2 as your fitness level increases. Do not let your heart rate exceed 220 minus your resting heart rate. Perform each rep of each exercise slowly and with perfect technique. Count three seconds up and three seconds down.

Any type of aerobic exercise can be used for this routine. Some examples are: jumping jacks, jogging in place, or stair climbing.

<b>Circuit 1</b>	<b>Body Part</b>	<b>Exercise</b>	<b>Reps</b>
	Chest	Bench Press	8-12
	Aerobic Exercise	30-60 Seconds	
	Legs	Squat	8-12
	Aerobic Exercise	30-60 Seconds	
	Back	Narrow Pulldown with Hand Grips	8-12
	Aerobic Exercise	30-60 Seconds	
	Legs	Standing Hip Abduction	8-12
	Aerobic Exercise	30-60 Seconds	
	Trunk	Seated Abdominal Crunch	8-12
	Aerobic Exercise	30-60 Seconds	

<b>Circuit 2</b>	<b>Body Part</b>	<b>Exercise</b>	<b>Reps</b>
	Shoulders	Seated Shoulder Press	8-12
	Aerobic Exercise	30-60 Seconds	
	Legs	Leg Extension	8-12
	Aerobic Exercise	30-60 Seconds	
	Back	Stiff Arm Pulldowns	8-12
	Aerobic Exercise	30-60 Seconds	
	Trunk	Standing Low Back Extension	8-12
	Aerobic Exercise	30-60 Seconds	
	Arms	Seated Biceps Curl	8-12



# Workouts

## Strength Training

**Frequency:** 3 days per week (M-W-F)

**Time:** 45-60 minutes

This program is designed to emphasize overall strength development. This is an advanced routine to be used only after you have progressed from the advanced general conditioning routine and only after you have perfected your exercise techniques. Work each set to near exhaustion. If you can perform more than 5 to 8 reps, you should increase your resistance 5 lbs and decrease your reps to 5. Rest 60–120 seconds between each set and exercise. Focus on proper form. Tighten the muscle before you move, squeeze the muscle as you move, cramp the muscle at the point of full contraction, and resist the movement as you lower the weight. Move slowly on each rep. Use a pace that would allow you to stop the movement instantly at any point in the rep. Count two seconds up and four seconds down and work to fatigue during each set.

### Day 1

Body Part	Exercise	Sets	Reps
Chest	Bench Press	2-4	5-8
	Decline Bench Press	2-4	5-8
Shoulders	Seated Shoulder Press	2-4	5-8
	Lateral Shoulder Raise	2-4	5-8
	Shoulder Shrug	2-4	5-8

### Day 2

Body Part	Exercise	Sets	Reps
Back	Reverse Grip Pulldown with Hand Grips	2-4	5-8
	Narrow Pulldown with Hand Grips	2-4	5-8
Arms	Seated Biceps Curl	2-4	5-8
	Triceps Kickback	2-4	5-8
	Triceps Pushdown	2-4	5-8
	Triceps Extension	2-4	5-8

### Day 3

Body Part	Exercise	Sets	Reps
Legs	Squat	2-4	5-8
	Leg Extension	2-4	5-8
	Standing Hip Extension	2-4	5-8
	Hip Abduction	2-4	5-8
Trunk	Standing Low Back Extension	2-4	5-8
	Seated Abdominal Crunch	2-4	5-8

# Exercises

## Chest Exercises

### Bench Press - Shoulder Horizontal Adduction (and elbow extension)

#### Muscles Worked

Pectoralis Major, Deltoids, Triceps

#### Machine Set-Up

- Seated - facing outward
- Chest Bar
- Leg extension removed
- Handgrips
- Attach the clips to the Power Rod® resistance rods.

#### Success Tips

- Maintain a 90° angle between your upper arms and torso throughout the motion.
- Keep your chest muscles tightened.
- Limit and control your range of motion
- Keep your knees bent, feet on the Platform and head back against the Seat Back Pad.
- Keep your elbows in front of your shoulders.
- Keep your shoulder blades pinched together and maintain good spinal alignment.

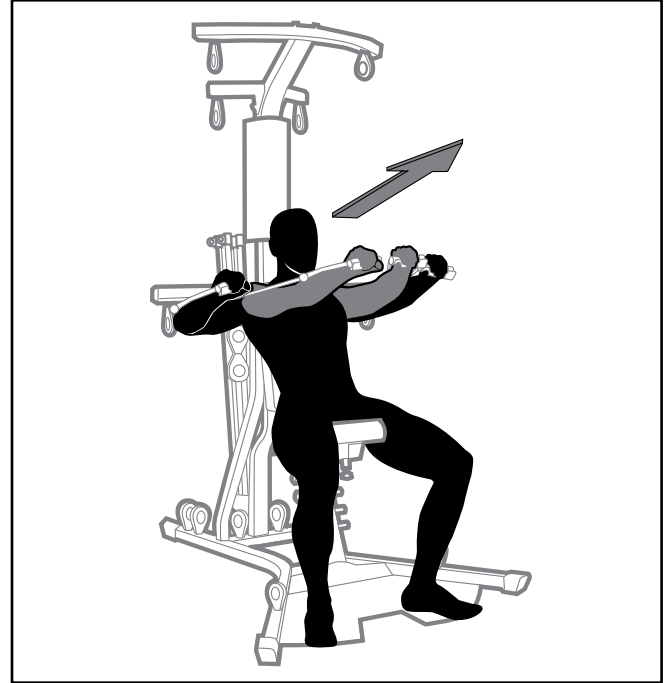

### Decline Bench Press - Shoulder Horizontal Adduction (and elbow extension)

#### Muscles Worked

Pectoralis Major, Deltoids, Triceps

#### Machine Set-Up

- Seated - facing outward
- Chest Bar
- Leg extension removed
- Handgrips
- Attach the clips to the Power Rod® resistance rods.

#### Success Tips

- Maintain a 90° angle between your upper arms and torso at the start of the motion, and slightly less than 90° at the finish.
- Keep your knees bent, feet on the Platform and head back against the Seat Back Pad.
- Do not let your elbows travel behind your shoulders.
- Keep your shoulder blades pinched together and maintain good spinal alignment.



# Exercises

## Chest Exercises

### Incline Bench Press - Shoulder Horizontal Adduction (and elbow extension)

#### Muscles Worked

Pectoralis Major, Deltoids, Triceps

#### Machine Set-Up

- Seated - facing outward
- Chest Bar
- Leg extension removed
- Handgrips
- Attach the clips to the Power Rod® resistance rods.

#### Success Tips

- Maintain a 90° angle between your upper arms and torso at the start of the motion, and slightly less than 90° at the finish.
- Keep your knees bent, feet on the Platform and head back against the Seat Back Pad.
- Do not let your elbows travel behind your shoulders.
- Keep your shoulder blades pinched together and maintain good spinal alignment.

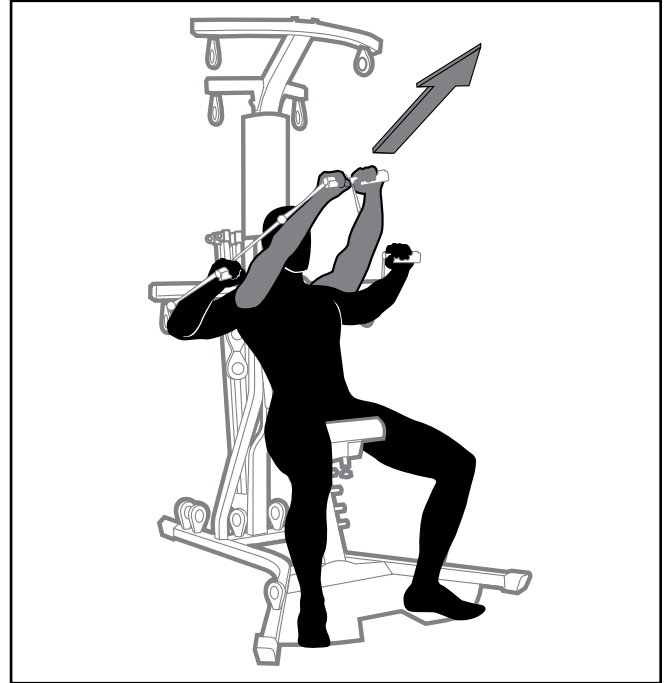

## Shoulder Exercises

### Crossover High Rear Delt Rows

#### Muscles Worked

Anterior and Middle Deltoids

#### Machine Set-Up

- Standing-facing Power Rod® unit
- Front Lat Cross Bar
- Leg extension and seat assembly removed
- Handgrips
- Attach the clips to the Power Rod® resistance rods.

#### Success Tips

- Maintain a 90° angle between your upper arms and torso during the motion.
- Keep your shoulder blades pinched together, abdominals tight, and maintain good spinal alignment.
- Keep your chest lifted throughout the exercise.

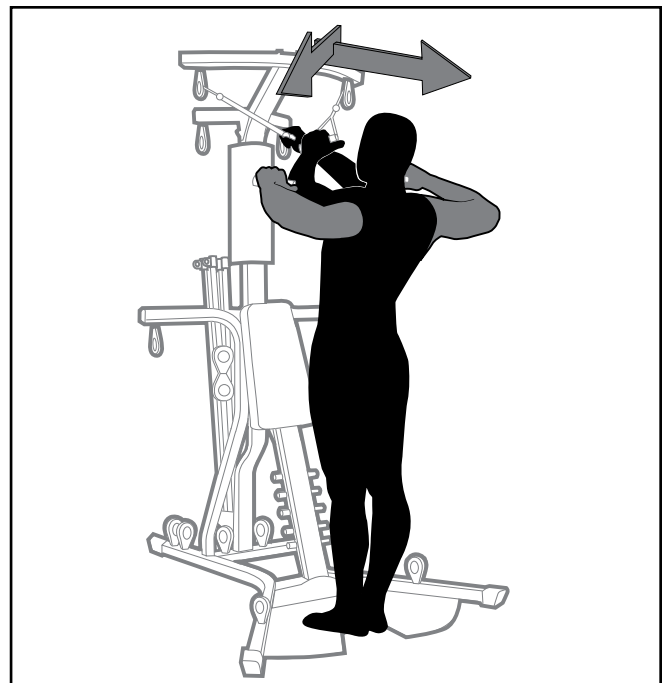

# Exercises

## Shoulder Exercises

### Seated Shoulder Press - Shoulder Adduction (and elbow extension)

#### Muscles Worked

Front Deltoids, Upper Trapezius, Triceps

#### Machine Set-Up

- Seated - facing outward
- Center Cross Bar
- Leg extension removed
- Handgrips
- Attach the clips to the Power Rod® resistance rods.

#### Success Tips

- Lift your chest, keep your knees bent and your feet on the Standing Platform.
- Do not increase the arch in your lower back as you raise your arms. Keep your spine steady and tight.
- Keep your abdominals tight and maintain good spinal alignment.



### Shoulder Shrug

#### Muscles Worked

Upper Trapezius

#### Machine Set-Up

- Standing - facing Power Rod® unit
- Squat Pulley Frame
- Leg extension and seat assembly removed
- Handgrips
- Attach the clips to the Power Rod® resistance rods.

#### Success Tips

- Keep your abdominals tight and maintain good spinal alignment.
- Do not bend your neck.
- Raise your shoulders evenly.
- For variation, perform this exercise bent slightly at the hips.

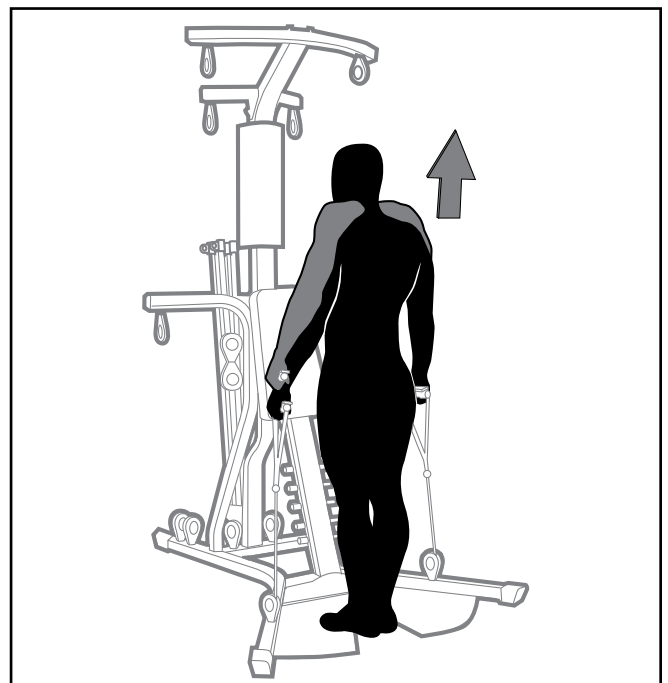

# Exercises

## Shoulder Exercises

### Lateral Shoulder Raise

#### Muscles Worked

Middle Deltoids, Supraspinatus, Upper Trapezius

#### Machine Set-Up

- Standing - facing outward
- Squat Pulley Frame
- Leg extension and seat assembly removed
- Handgrips
- Attach the clips to the Power Rod® resistance rods.

#### Success Tips

- Elevate your shoulders slightly toward the back of your head.
- Maintain good spinal alignment and bend forward slightly from your hips.
- Do not swing your arms upward or move your trunk during this exercise.
- Lift your chest, keep your knees bent and your feet on the Standing Platform.

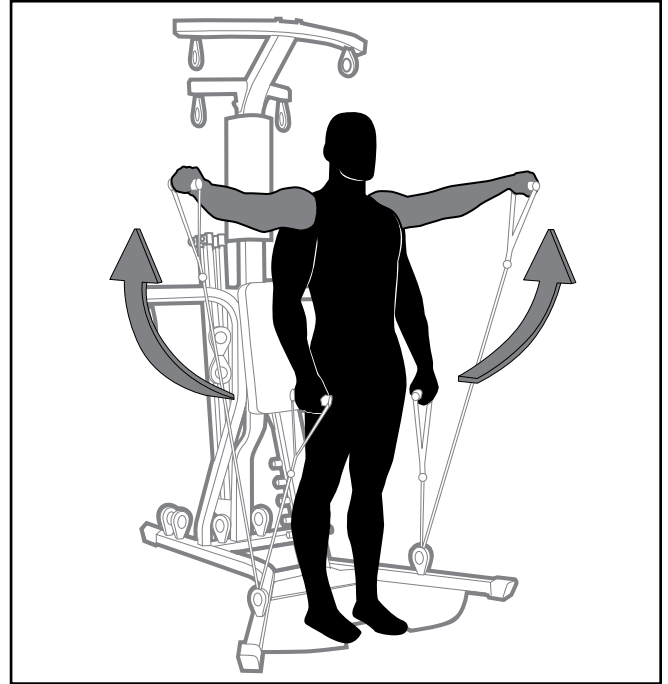

### Shoulder Rotator Cuff - (Internal)

#### Muscles Worked

Subscapularis

#### Machine Set-Up

- Standing - facing left or right
- Chest Bar
- Leg extension and seat assembly removed
- Handgrips
- Attach the clips to the Power Rod® resistance rods.

#### Success Tips

- Lift your chest, keep your knees bent and your feet on the Standing Platform.
- Keep your spine aligned and a slight arch in your back.
- Maintain a 90° angle between your forearms and your torso throughout the exercise.
- Do not rotate your spine to get additional range of motion.

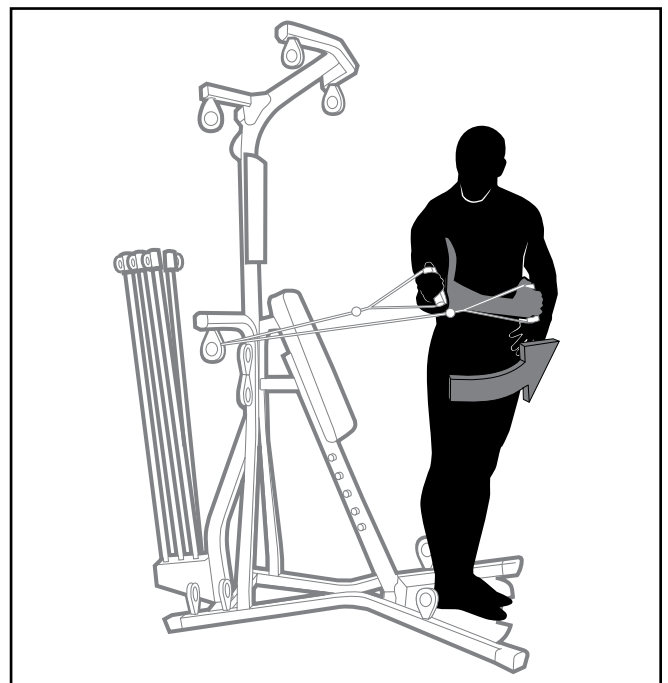

# Exercises

## Shoulder Exercises

### Shoulder Rotator Cuff - (External)

#### Muscles Worked

Infraspinatus, Teres Minor

#### Machine Set-Up

- Standing - facing left or right
- Chest Bar
- Leg extension and seat assembly removed
- Handgrips
- Attach the clips to the Power Rod® resistance rods.

#### Success Tips

- Lift your chest, keep your knees bent and your feet on the Standing Platform.
- Keep your spine aligned and a slight arch in your back.
- Maintain a 90° angle between your forearms and your torso throughout the exercise.
- Do not rotate your spine to get additional range of motion.

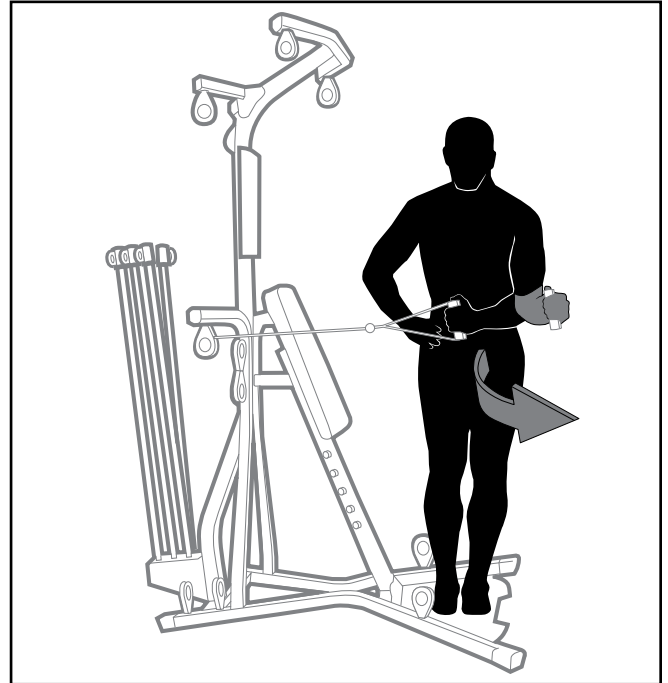

## Back Exercises

### Standing Low Back Extension

#### Muscles Worked

Lower Trapezius, Erector Spinae, Gluteus Maximus

#### Machine Set-Up

- Standing - facing outward
- Squat Pulley Frame
- Leg extension and seat assembly removed
- Handgrips
- Attach the clips to the Power Rod® resistance rods.

#### Success Tips

- Lift your chest, keep your knees bent and your feet on the Standing Platform.
- Pinch your shoulder blades together.
- Keep your spine aligned and a slight arch in your back.
- Move from hips only. Do not bend from your waist.



# Exercises

## Back Exercises

### Narrow Pulldowns with Hand Grips - Shoulder Extension (with elbow flexion)

#### Muscles Worked

Latissimus Dorsi, Teres Major, Rear Deltoids, Biceps

#### Machine Set-Up

- Seated - Facing the Power Rod® unit
- Front Lat Cross Bar
- Leg extension removed
- Handgrips
- Attach the clips to the Power Rod® resistance rods.

#### Success Tips

- Keep your chest lifted, knees bent and your feet flat on the floor.
- Do not bend your neck forwards or backwards during the motion.
- Keep your spine aligned, abs tight and a slight arch in your lower back. Do not slouch.



### Stiff Arm Pulldowns

#### Muscles Worked

Latissimus Dorsi, Teres Major, Rear Deltoids, Lower Trapezius, Biceps

#### Machine Set-Up

- Standing - Facing the Power Rod® unit
- Front Lat Cross Bar
- Leg extension and seat assembly removed
- Handgrips
- Attach the clips to the Power Rod® resistance rods.

#### Success Tips

- Keep your lats tightened throughout the exercise.
- Keep your chest lifted and maintain spinal alignment with a slight arch in your lower back.
- Release your shoulder blades at the end of each rep.
- Initiate each new rep by depressing your shoulder blades.
- Keep your elbows nearly straight (do not lock your elbows) throughout the exercise.

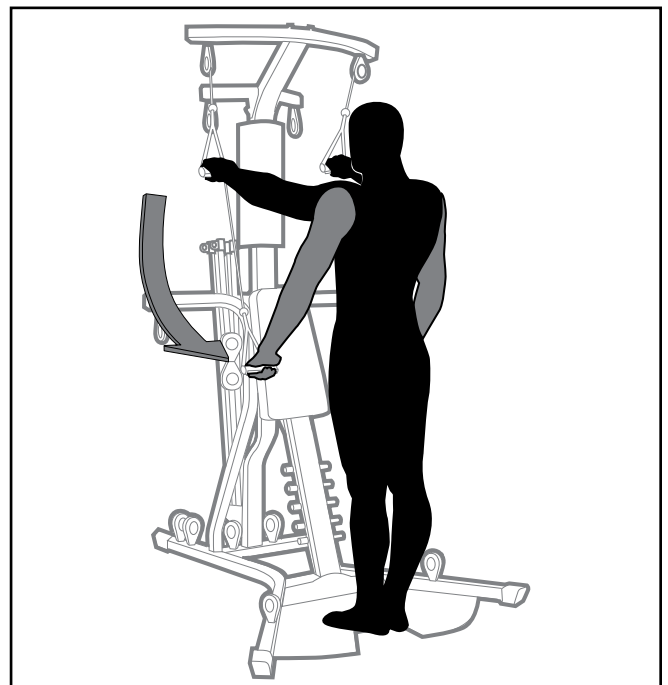

# Exercises

## Back Exercises

### Reverse Grip Pulldown with Hand Grips

#### Muscles Worked

Latissimus Dorsi, Teres Major, Rear Deltoids, Biceps

#### Machine Set-Up

- Seated - Facing Power Rod® unit
- Front Lat Cross Bar
- Leg extension removed
- Handgrips
- Attach the clips to the Power Rod® resistance rods.

#### Success Tips

- Lift your chest, keep your knees bent and your feet on the Standing Platform.
- Do not bend your neck forwards or backwards during the motion.
- Keep your spine aligned, abs tight and a slight arch in your lower back. Do not slouch.



## Arm Exercises

### Triceps Pushdown - Elbow Extension

#### Muscles Worked

Triceps

#### Machine Set-Up

- Standing - Facing Power Rod® unit
- Front Lat Cross Bar
- Leg extension and seat assembly removed
- Handgrips
- Attach the clips to the Power Rod® resistance rods.

#### Success Tips

- Keep your upper arms motionless and your wrists straight.
- Keep your chest lifted, abs tight and maintain a slight arch in your lower back.
- Use a controlled motion and tighten your triceps throughout the exercise.

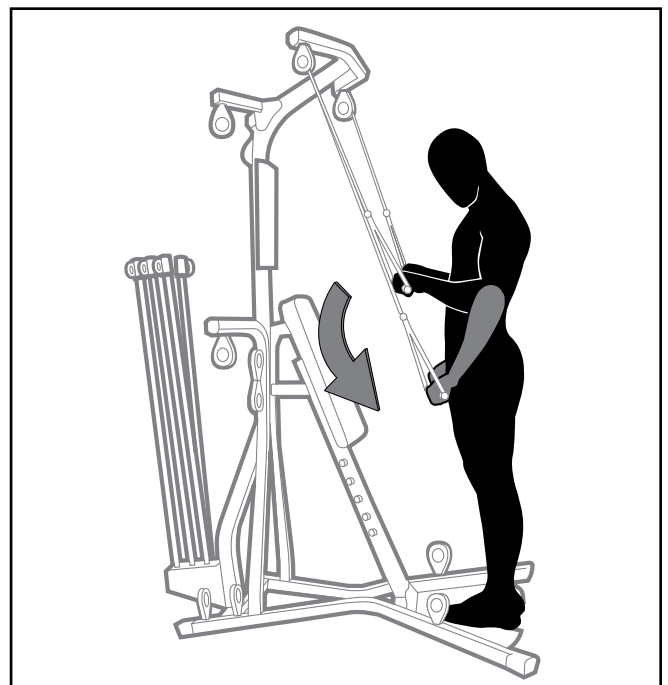



# Exercises

## Arm Exercises

### Triceps Extension

#### Muscles Worked

Triceps

#### Machine Set-Up

- Seated - Facing outward
- Chest Bar
- Leg extension removed
- Handgrips
- Attach the clips to the Power Rod® resistance rods.

#### Success Tips

- Keep your upper arms motionless and your wrists straight.
- Keep your chest lifted, abs tight and maintain a slight arch in your lower back.
- Use a controlled motion and tighten your triceps throughout the exercise.

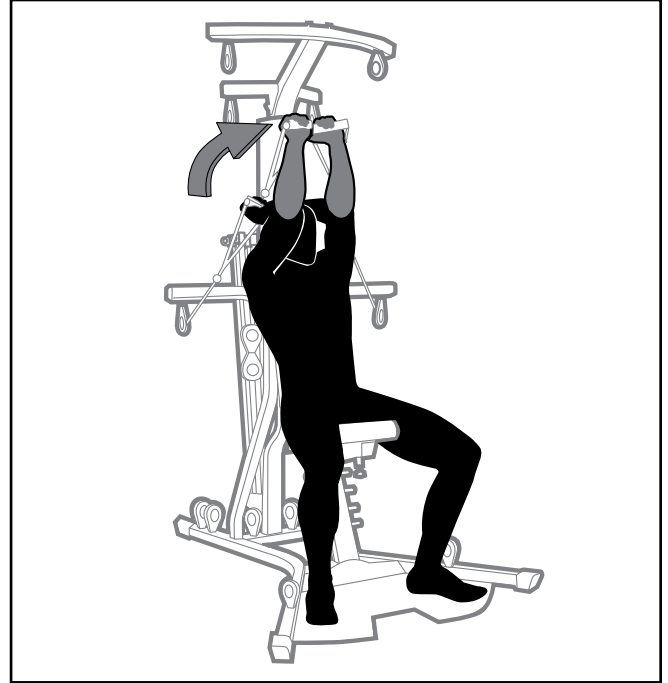

### Seated Biceps Curl

#### Muscles Worked

Biceps

#### Machine Set-Up

- Seated - Facing outward
- Squat Pulley Frame
- Leg extension removed
- Handgrips
- Attach the clips to the Power Rod® resistance rods.

#### Success Tips

- Keep your knees bent and your feet flat on the Standing Platform.
- Keep your chest lifted, shoulders pinched together and a very slight arch in your back.
- Lay your head back against the Seat Back Pad.



# Exercises

## Arm Exercises

### Triceps Kickback

#### Muscles Worked

Triceps

#### Machine Set-Up

- Standing - Facing Power Rod® unit
- Chest Bar
- Leg extension and seat assembly removed
- Handgrips
- Attach the clips to the Power Rod® resistance rods.

#### Success Tips

- Keep your knees bent slightly and your feet on the Standing Platform
- Keep your chest lifted, trunk muscles tightened and a very slight arch in your lower back.
- Keep one hand on the Center Cross Bar to stabilize yourself throughout the motion.
- Keep your triceps tightened throughout the exercise.

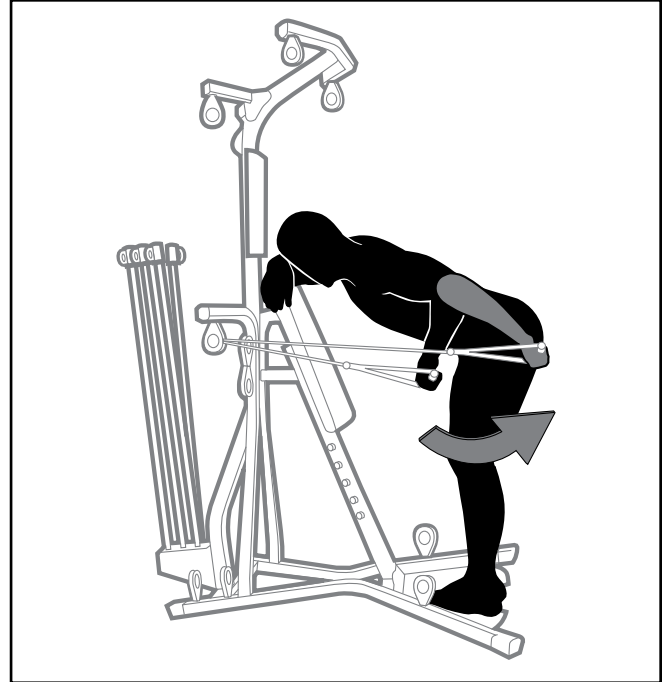

## Abdominal Exercises

### Seated (Resisted) Abdominal Crunch - Spinal Flexion

#### Muscles Worked

Rectus Abdominus, Obliques

#### Machine Set-Up

- Seated - Facing outward
- Chest Bar
- Leg extension removed
- Handgrips
- Attach the clips to the Power Rod® resistance rods.

#### Success Tips

- Do not lift your head or chin. Your head should follow the rib motion rather than lead it.
- Maintain normal neck posture.
- Tighten your abs throughout the entire exercise and relax only at the end of each set.
- Move slowly to eliminate momentum.
- Exhale during the upward movement and inhale during the downward movement.

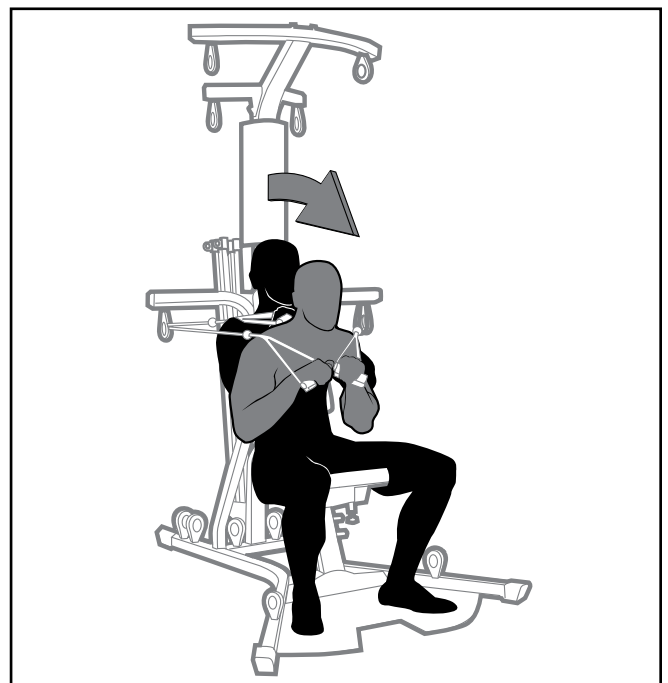

# Exercises

## Abdominal Exercises

### Trunk Rotation

#### Muscles Worked

Rectus Abdominus, Obliques, Serratus Anterior

#### Machine Set-Up

- Standing - Facing right or left
- Chest Bar
- Leg extension and seat assembly removed
- Handgrips
- Attach the clips to the Power Rod® resistance rods.

#### Success Tips

- Keep your chest lifted, shoulders pinched, abs tight and a slight arch in your lower back.
- Use only low weight Rods.
- Keep all motion in your torso.
- Move only as far as your muscles let you. Do not use momentum to increase your range of motion.

**!** Failure to perform this exercise correctly could result in injury. Use only low weight Power Rods.

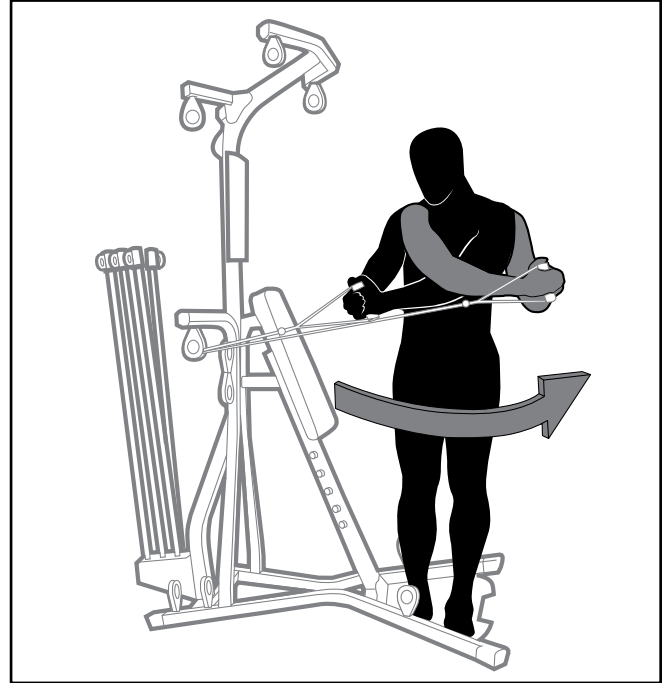

## Leg Exercises

### Leg Extension

#### Muscles Worked

Quadriceps

#### Machine Set-Up

- Seated - Facing outward
- Center Cross Bar
- Leg extension removed
- Handgrips
- Attach the clips to the Power Rod® resistance rods.

#### Success Tips

- Use slow, controlled motion. Do not kick into the extension.
- Do not let your knees rotate outward during the exercise. Keep your kneecaps pointing up and straight forward.

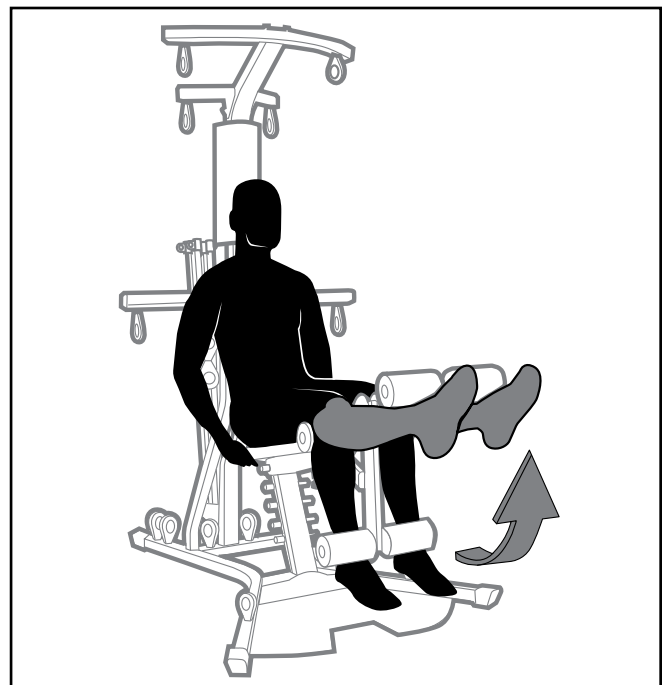

# Exercises

## Leg Exercises

### Squat

#### Muscles Worked

All leg muscles, Gluteus Maximus

#### Machine Set-Up

- Standing - facing outward
- Squat Pulley Frame
- Leg extension and seat assembly removed
- Handgrips
- Attach the clips to the Power Rod® resistance rods.

#### Success Tips

- Keep your chest lifted, spine aligned, abs tight and a very slight arch in your lower back.
- Do not bend from your waist or lower back.
- Keep your abs tight throughout the exercise.
- Never step off of the Stand Platform while doing the exercise.

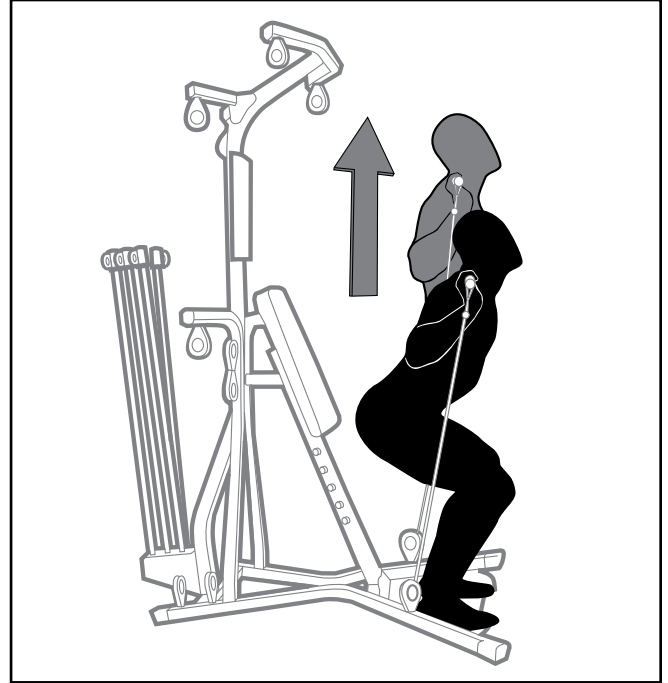

### Standing Hip Extension

#### Muscles Worked

Gluteus Maximus

#### Machine Set-Up

- Standing - Facing Power Rod® unit
- Squat Pulley Frame
- Leg extension and seat assembly removed
- Handgrips
- Attach the clips to the Power Rod® resistance rods.

#### Success Tips

- Keep your knees slightly bent and your support foot on the Standing Platform.
- Keep your chest lifted, spine aligned, abs tight and a very slight arch in your lower back.
- Do not bend from your waist or lower back.
- Keep working leg straight or only slightly bent.



# Exercises

## Leg Exercises

### Standing Hip Abduction

#### Muscles Worked

Gluteus Maximus

#### Machine Set-Up

- Standing - Facing right or left
- Squat Pulley Frame
- Leg extension and seat assembly removed
- Handgrips
- Attach the clips to the Power Rod® resistance rods.

#### Success Tips

- Keep your chest lifted, spine aligned, abs tight and a very slight arch in your lower back.
- This exercise does not burn fat from the hips but builds strength and stability.
- Keep your working leg straight or only very slightly bent and your hips level.
- Use only a small range of motion.



### Standing Hip Adduction

#### Muscles Worked

Gluteus Maximus, Adductor Longus

#### Machine Set-Up

- Standing - Facing right or left
- Squat Pulley Frame
- Leg extension and seat assembly removed
- Handgrips
- Attach the Hand Grip to the Cables farthest from the active ankle.

#### Success Tips

- Do not cross the attached leg in front of the stabilized leg.
- Keep your abs tight and do not lift your hips or excessively arch your back.
- Keep your spine straight and your hips level.
- Do not raise your hips during the motion.
- Use only a small range of motion.

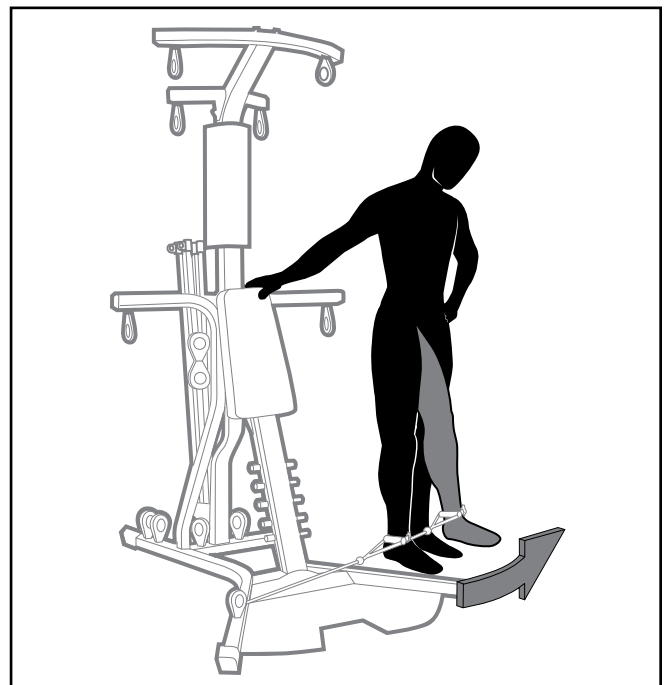

# Exercises

## Leg Exercises

### Standing Leg Kickback - Hip and Knee Extension

#### Muscles Worked

Piriformus, Gluteus Maximus

#### Machine Set-Up

- Standing - Facing Power Rod® unit
- Squat Pulley Frame
- Leg extension and seat assembly removed
- Handgrips
- Attach the clips to the Power Rod® resistance rods.

#### Success Tips

- Keep your knees slightly bent and your support foot on the Standing Platform.
- Keep your chest lifted, spine aligned, abs tight and a very slight arch in your lower back.
- Do not bend from your waist or lower back.
- Allow your active leg to hang in the direction of the cable throughout the movement.

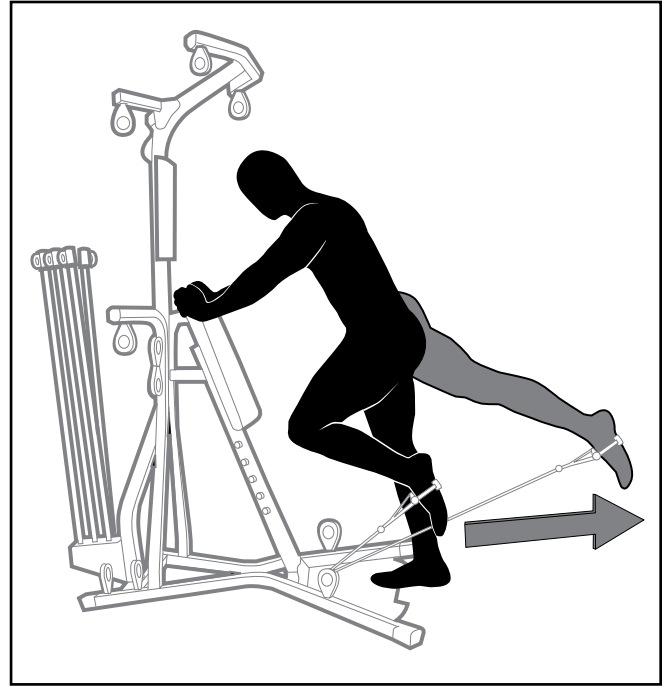

### Standing Calf Raise

#### Muscles Worked

Gastrocnemius, Soleus

#### Machine Set-Up

- Standing - Facing Power Rod® unit
- Squat Pulley Frame
- Leg extension and seat assembly removed
- Handgrips
- Attach the clips to the Power Rod® resistance rods.

#### Success Tips

- Keep your knees slightly bent and your toes/ balls of feet on the Standing Platform.
- Keep your chest lifted, spine aligned, abs tight and a very slight arch in your lower back.
- All motion is from ankle.
- Pivot entire body upward from balls of feet.

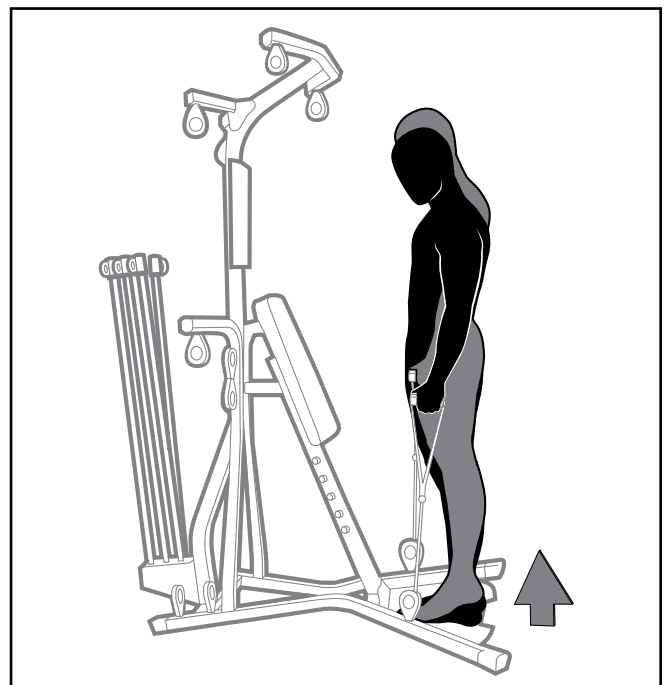

# Contacts

## UNITED STATES

CUSTOMER SERVICE email  
customerservice@nautilus.com

TECHNICAL/CUSTOMER SERVICE  
Tel: (800) NAUTILUS, (800-628-8458)  
Fax: (877) 686-6466  
E-mail: cstech@nautilus.com

CORPORATE HEADQUARTERS  
Nautilus, Inc.  
World Headquarters  
16400 SE Nautilus Drive  
Vancouver, Washington, USA 98683  
Phone: (800) NAUTILUS (800) 628-8458

## INTERNATIONAL

For technical assistance and a list of distributors in your area, please call or fax one of the following numbers.

INTERNATIONAL CUSTOMER SERVICE  
Nautilus International S.A.  
Rue Jean Prouvé  
1762 Givisiez / Switzerland  
Tel: + 41 26 460 77 77  
Fax: + 41 26 460 77 70  
E-mail: technics@nautilus.com

GERMANY and AUSTRIA  
Nautilus Deutschland GmbH  
Albin-Köbis-Str. 4  
51147 Köln  
Tel: + 49 02203 2020 0  
Fax: + 49 02203 2020 45 45

ITALY  
Nautilus Italy S.r.l., Via della Mercanzia, 103  
40050 Funo di Argelato - Bologna  
Tel: + 39 051 664 6201  
Fax: + 39 051 664 7461

SWITZERLAND  
Nautilus Switzerland SA  
Rue Jean-Prouvé 6  
CH-1762 Givisiez  
Tel: + 41 26 460 77 66  
Fax: + 41 26 460 77 60

UNITED KINGDOM  
Nautilus UK Ltd  
4 Vincent Avenue  
Crownhill, Milton Keynes, Bucks, MK8 0AB  
Tel: + 44 1908 267 345  
Fax: + 44 1908 267 345

CHINA  
Nautilus (Shanghai) Fitness Co., Ltd.  
7A No.728, Yan'an Road (West)  
200050 Shanghai, China  
Tel: + 86 21 523 707 00  
Fax: + 86 21 523 707 09

**Serial Number**

**Date of Purchase**



Printed in China

©2008. Nautilus, Inc. All rights reserved. Nautilus, the Nautilus Logo, Universal, the Universal Logo, Bowflex, the Bowflex logo, Power Rod, StairMaster and Nautilus Institute are either registered trademarks or trademarks of Nautilus, Inc. Schwinn is a registered trademark. All other trademarks are owned by their respective companies. Nautilus, Inc., World Headquarters, 16400 SE Nautilus Drive, Vancouver, WA 98683 1-800-NAUTILUS [www.nautilus.com](http://www.nautilus.com)

Nautilus® Bowflex® Schwinn® Fitness StairMaster® Universal® Nautilus Institute®